

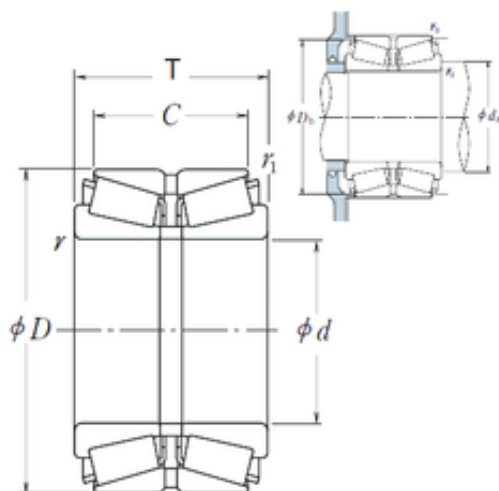

BEARING USA CORP.

NSK HR70KBE43+L tapered roller bearings



Bearing No. HR70KBE43+L

Size	70x150x83 mm
Bore Diameter	70 mm
Outer Diameter	150 mm
Width	83 mm
d	70 mm
D	150 mm
T	83 mm
C	67 mm
r min.	3 mm
r1 min.	1 mm
da min.	88 mm
Db min.	142 mm
ra max.	2,5 mm
rb max.	1 mm
Weight	6,45 Kg
Basic dynamic load rating (C)	390 kN
Basic static load rating (C0)	535 kN
(Grease) Lubrication Speed	2000 r/min
(Oil) Lubrication Speed	2700 r/min
Calculation factor (e)	0,35
Calculation factor (Y0)	1,9
Calculation factor (Y2)	2,9

HR70KBE43+L Bearing 2D drawings and 3D CAD models